

Indigo™ Series 1000 Ice Cube Machine

Model: ID-1002A IY-1004A ID-1003W IY-1005W ID-1092N IY-1094N



Indigo Series i-1000
Ice Machine on B-570 Bin

Designed for operators who know that ice is critical to their business, the Indigo™ Series ice machine's preventative diagnostics continually monitor itself for reliable ice production. Improvements in cleanability and programmability make your ice machine easy to own and less expensive to operate.

- **Space-Saving Design** – Up to 1,020 lbs. (463 kgs.) daily ice production and only 30" (76.20 cm) wide.
- **Intelligent Diagnostics** – provide 24 hour preventative maintenance and diagnostic feedback for trouble free operation.
- **Acoustical Ice Sensing Probe** – for reliable operation in challenging water conditions.
- **EasyRead Display** – communicates operating status, cleaning reminders, and asset information through a blue illuminated display.
- **Programmable Ice Production** – by On/Off Time, Ice Volume or Bin Level (with accessory bin level control) further improves energy efficiency and savings.
- **Easy to Clean Foodzone** – Hinged front door swings out for easy access. Removable water-trough, distribution tube, curtain, and sensing probes for fast and efficient cleaning. Select components made with AlphaSan® antimicrobial.
- **DuraTech™ Exterior** – provides superior corrosion resistance. Stainless finish with innovative clear-coat resists fingerprints and dirt.
- Available **LuminIce™ Growth Inhibitor** controls the growth of bacteria and yeast within the foodzone.

Ice Machine Electric

208-230/60/1 standard
(208-230/60/3 and 230/50/1 also available.)

Minimum circuit ampacity:

Air-cooled:	13.5 1ph	9.5 3ph
Water-cooled:	9.7 1ph	8.5 3ph
Remote:	10.7 1ph	9.5 3ph

Maximum fuse size:

Air-cooled:	20 1ph	15 3ph
Water-cooled:	15 1ph	15 3ph
Remote:	15 1ph	15 3ph

Specifications

BTU Per Hour:

16,250 (average) 18,600 (peak)

Refrigerant:

R-404A CFC-free

Operating Limits:

- Ambient Temperature Range: 35° to 110°F (1.7° to 43.3°C)
Water Temperature Range: 35° to 90°F (1.7° to 32.2°C)
- Water Pressure Ice Maker Water In:
Min. 20 psi (137.9 kPa)
Max. 80 psi (551.1 kPa)



Ice Shape



Half Dice
3/8" x 1 1/8" x 7/8"
(.95 x 2.86 x 2.22 cm)



Dice
7/8" x 7/8" x 7/8"
(2.22 x 2.22 x 2.22 cm)





Indigo™ Series 1000 Ice Cube Machine

i-1000 on B-570 Storage Bin

- Ⓐ Electrical Entrance (2) Options
- Ⓑ 3/8" (0.95 cm) F.P.T. Water Condenser Inlet (water-cooled units)
- Ⓒ 1/2" (1.27 cm) F.P.T. Water Condenser Outlet (water-cooled units)
- Ⓓ 1/2" (1.27 cm) Auxillary Base Drain Socket
- Ⓔ 3/8" (0.95 cm) F.P.T. Ice Making Water Inlet
- Ⓕ 1/2" (1.27 cm) F.P.T. Ice Making Water Drain
- Ⓖ 3/4" (1.91 cm) Bin Drain

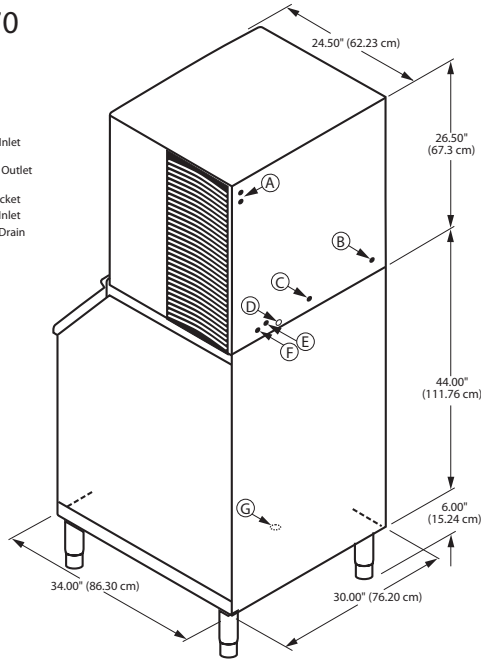

Installation Note
Minimum installation clearance:
Top/sides: 8" (20.32 cm);
Back is 5" (12.7 cm)

Space-Saving Designs



	i-1000 B-570	i-1000 B-970*
Height	76.50" 194.30 cm	76.50" 194.30 cm
Width	30.00" 76.20 cm	48.00" 121.92 cm
Depth	34.00" 86.30 cm	34.00" 86.30 cm
Bin Storage	430 lbs. 195 kgs.	710 lbs. 322.2 kgs.

Height includes adjustable bin legs 6.00" to 8.00", (15.24 to 20.32 cm) set at 6.00" (15.24 cm).

*K-00370 bin adapter required.

Specifications

	Model	Ice Shape	Ice Production 24 Hours		Power Usage kWh/100 lbs. @90°Air/70°F		Water Usage/ 100 lbs. 45.4 kgs. of Ice	ENERGY STAR*
			70°Air/ 50°F Water	90°Air/ 70°F Water	1 Ph	3 Ph	Potable Water	
AIR-COOLED	ID-1002A	dice	990 lbs.	735 lbs.	5.41	5.41	19.8 Gal.	★
			449 kgs.	333 kgs.			75.0 L	
AIR-COOLED	IY-1004A	half-dice	1,010 lbs.	745 lbs.	5.36	5.36	19.8 Gal.	★
			458 kgs.	338 kgs.			75.0 L	
WATER-COOLED	ID-1003W	dice	1,000 lbs.	855 lbs.	4.23	4.23	19.8 Gal.	NA
			454 kgs.	388 kgs.			75.0 L	
WATER-COOLED	IY-1005W	half-dice	1,010 lbs.	870 lbs.	4.07	4.07	19.8 Gal.	NA
			458 kgs.	395 kgs.			75.0 L	
* Water-cooled Condenser Water Usage / 100 lbs. /45.4 kgs. Of Ice: 180 gal/681 L.								
* Water-cooled models are excluded from ENERGY STAR qualification.								
REMOTE-COOLED	ID-1092N	dice	960 lbs.	725 lbs.	5.50	5.50	19.8 Gal.	★
			435 kgs.	329 kgs.			75.0 L	
REMOTE-COOLED	IY-1094N	half-dice	1,020 lbs.	775 lbs.	5.28	5.28	19.8 Gal.	★
			463 kgs.	352 kgs.			75.0 L	

Order ice storage bin separately. Ice storage bin and JC-0995 remote condenser must be ordered separately. Consult remote condenser specification sheet for details. To order 3 phase add "3" suffix to model # (ID-1002A3).

Accessories

LuminIce™ Growth Inhibitor
reduces yeast and bacteria growth for a cleaner ice machine.



Bin Level Control
Allows ice bin level to be automatically set. Built-in LED light illuminates bin.



Arctic Pure® Water Filters
Reduces sediment and chlorine odors for better tasting ice.



AuCS®
schedules and performs routine ice machine cleaning automatically.

